



## BTI-1700R

### Category

Modica Right Corner Freestanding Bath 1700

### Size

1700L x 730W x 580H mm

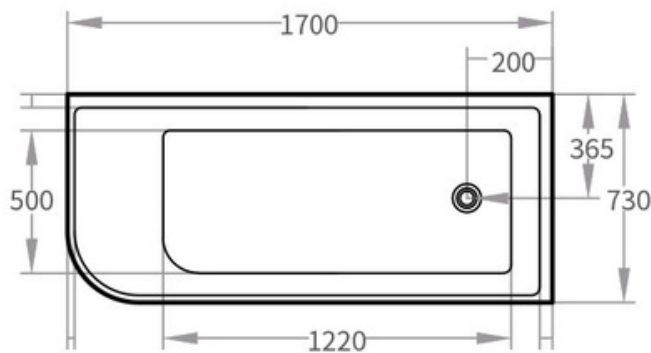

NOTE: Product dimensions are approximate and can vary slightly due to manufacturing variances. Information provided in this data sheet is representative of the product available at the time and date of printing, 1/5/2021. Builders World Pty Ltd reserves the right to vary specifications at any time without notice.

buildersworld.com.au  
1300 269 753

Refer to Warranty Sheet for  
Warranty Conditions and Cleaning  
Recommendations.

# [D]

DOMESTIC APPLICATIONS  
10 year replacement warranty on bath  
shell. 1 year warranty on labour.

# [C]

COMMERCIAL USE WARRANTY  
1 year parts & replacement  
(unless extended Warranty provided  
in writing by Builders World).

# [O]

OUTDOOR APPLICATIONS  
Warranty does not cover products  
used for outdoor applications.